

## Slim-Smartline

1 Tap hole  
1 Cabinet

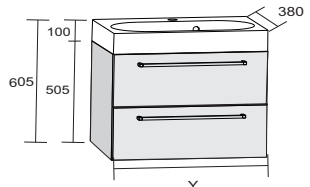

Y = 600mm/800mm/1000mm

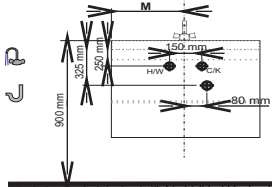

2 Tap holes  
1 Cabinet

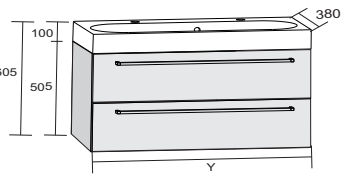

Y = 1000mm

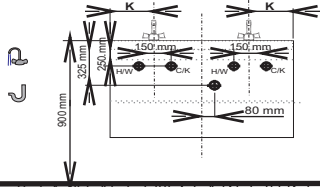

2 Tap holes  
2 Cabinets

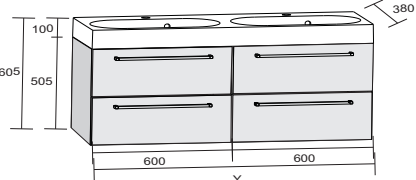

Y = 2x600mm

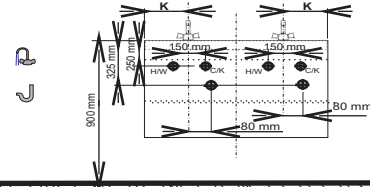

2 Tap holes  
2 Cabinets

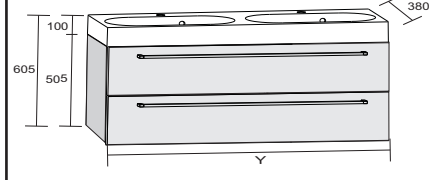

Y = 1200mm

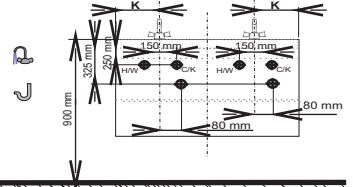

## Scala/Senso

1 Tap hole  
1 Cabinet

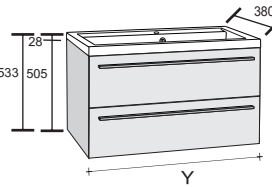

Y = 600mm/800mm

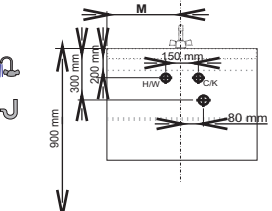

2 Tap holes  
1 Cabinet

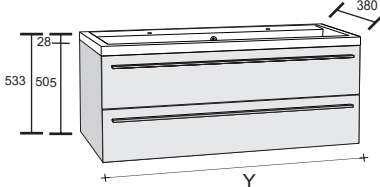

Y = 1000mm

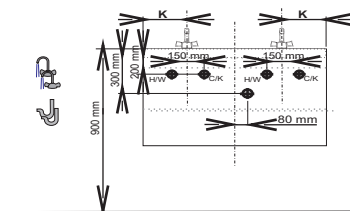

2 Tap holes  
2 Cabinets

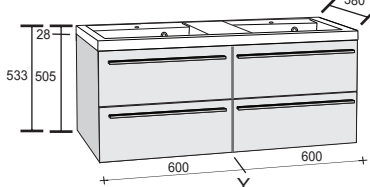

Y = 2x600mm

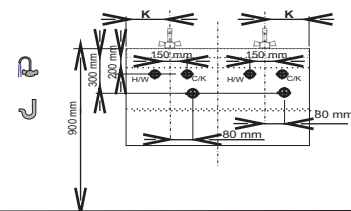

2 Tap holes  
2 Cabinets

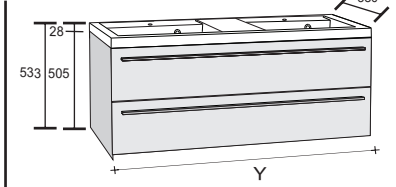

Y = 1200mm

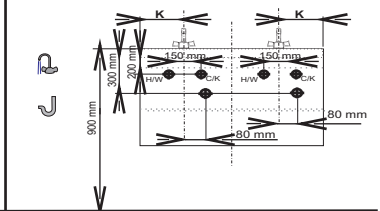

	X
SLIM-SMARTLINE	624mm
SCALA-SENSO	696mm

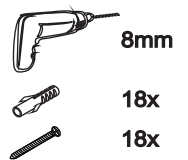
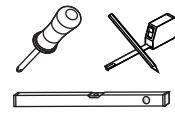
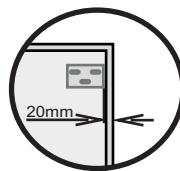
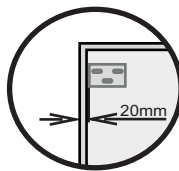

## 2 DRAWERS

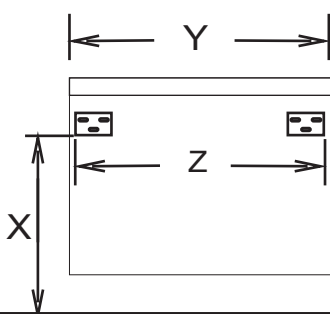

Y	Z
600	560
800	760
1000	960

## 4 DRAWERS

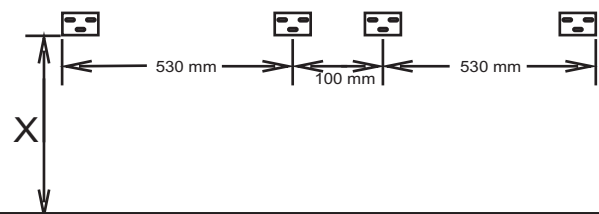

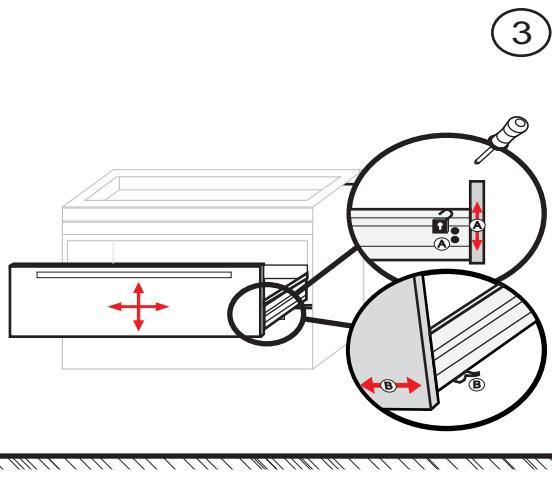
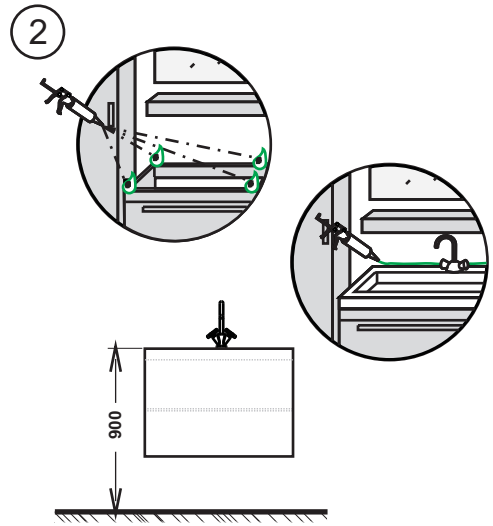
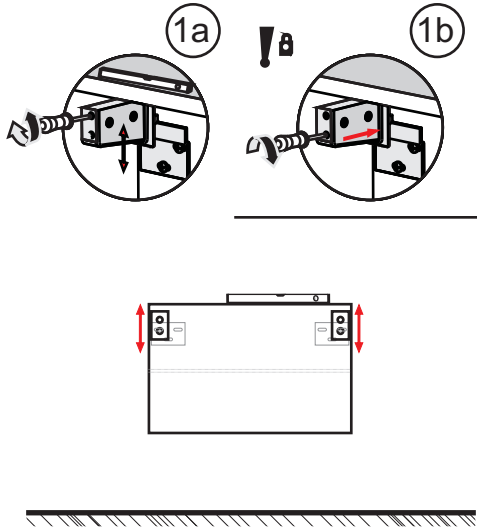

OUT

IN

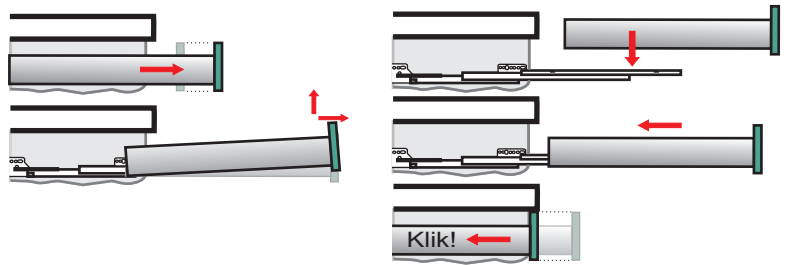

## Slim-Smartline

